

YAMAHA K-600

*Natural Sound Stereo Cassette Deck
Automatic Reverse with Fast-Response Optical Tape-End Detector
Car EQ Function for Road-Tailored Recording
Dolby® B/C Noise Reduction, Linear LED Tape Counter
Auto-Fade at Tape End and Beginning of Second Side
Remaining Tape Time Display, Blank Skip, Intro Scan, Auto Source Change Functions*

Thank you for purchasing the YAMAHA K-600 stereo cassette deck.

CONTENTS

CAUTION	1/2
CONNECTION DIAGRAM	3
FRONT PANEL PARTS AND FUNCTIONS	4/5/6
REMAINING TIME AUTO FADE OUT SWITCH OPERATION	7
DOLBY C-TYPE NOISE REDUCTION	7
LINEAR COUNTER	8
CAR EQ	8
RECORDING AND PLAYBACK	9
TIMER RECORDING/PLAYBACK	10
MAJOR FUNCTIONS	11
CASSETTE TAPES	12
TROUBLESHOOTING	13
SPECIFICATIONS	14

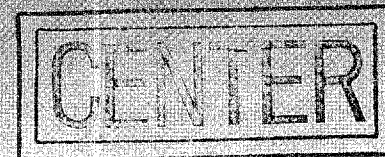

OWNER'S MANUAL

IMPORTANT

Please record the serial number of your unit in the space below.

Model: K-600

Serial No.:

The serial number is located on the rear of the cabinet.
Retain this Owner's Manual in a safe place for future reference.

WARNING

To prevent fire or shock hazard, do not expose this appliance to rain or moisture.



CAUTION (PREPARED IN ACCORDANCE WITH UL STANDARD 1270)

- 1** Read Instructions — All the safety and operating instructions should be read before the appliance is operated.
- 2** Retain Instructions — The safety and operating instructions should be retained for future reference.
- 3** Heed Warnings — All warnings on the appliance and in the operating instructions should be adhered to.
- 4** Follow Instructions — All operating and other instructions should be followed.
- 5** Water and Moisture — The appliance should not be used near water — for example, near a bathtub, washbowl, kitchen sink, laundry tub, in a wet basement, or near swimming pool, etc.
- 6** Carts and Stands — The appliance should be used only with a cart or stand that is recommended by the manufacturer.
- 7** Wall or Ceiling Mounting — The appliance should be mounted to a wall or ceiling only as recommended by the manufacturer.
- 8** Ventilation — The appliance should be situated so that its location or position does not interfere with its proper ventilation. For example, the appliance should not be situated on a bed, sofa, rug, or similar surface that may block the ventilation openings; or placed in a built-in installation, such as a bookcase or cabinet that may impede the flow of air through the ventilation openings.
- 9** Heat — The appliance should be situated away from heat sources such as radiators, stoves, or other appliances that produce heat.
- 10** Power Sources — The appliance should be connected to a power supply only of the type described in the operating instructions or as marked on the appliance.
- 11** Power-Cord Protection — Power-supply cords should be routed so that they are not likely to be walked on or pinched by items placed upon or against them, paying particular attention to cords at plugs, convenience receptacles, and the point where they exit from the appliance.
- 12** Cleaning — The appliance should be cleaned only as recommended by the manufacturer.
- 13** Nonuse Periods — The power cord of the appliance should be unplugged from the outlet when left unused for a long period of time.
- 14** Object and Liquid Entry — Care should be taken so that objects do not fall into and liquids not spilled into the inside of the appliance.
- 15** Damage Requiring Service — The appliance should be serviced by qualified service personnel when:
 - A. The power-supply cord or the plug has been damaged; or
 - B. Objects have fallen, or liquid has been spilled into the appliance; or
 - C. The appliance has been exposed to rain; or
 - D. The appliance does not appear to operate normally or exhibits a marked change in performance; or
 - E. The appliance has been dropped, or the cabinet damaged.
- 16** Servicing — The user should not attempt to service the appliance beyond those means described in the operating instructions. All other servicing should be referred to qualified service personnel.

K-600

CAUTION: READ THIS BEFORE OPERATING YOUR K-600

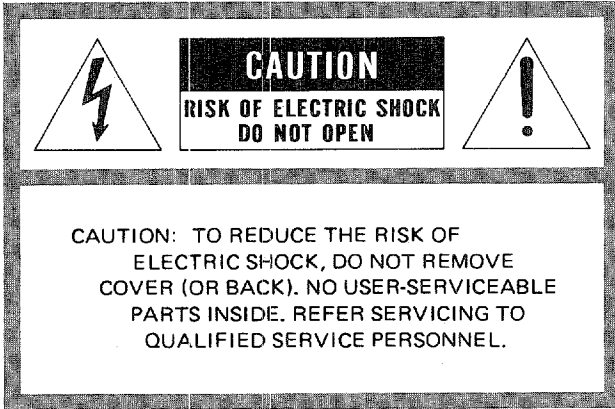

• Explanation of Graphical Symbols

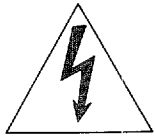

The lightning flash with arrowhead symbol, within an equilateral triangle, is intended to alert you to the presence of uninsulated "dangerous voltage" within the product's enclosure that may be of sufficient magnitude to constitute a risk of electric shock to persons.

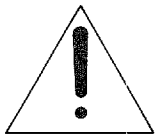

The exclamation point within an equilateral triangle is intended to alert you to the presence of important operating and maintenance (servicing) instructions in the literature accompanying the appliance.

1

The K-600 is a sophisticated stereo cassette deck. To ensure proper operation for the best possible performance, please read this manual carefully.

2

Choose the installation of your K-600 carefully. Avoid placing it in direct sunlight or close to a source of heat. Also avoid locations subject to vibration and excessive dust, heat, cold or moisture. Keep it away from such sources of hum as transformers or motors.

3

Do not open the cabinet as this may result in damage to the deck or electrical shock. If a foreign object should get into the deck, contact your local dealer.

4

When removing the power plug from the wall outlet, always pull directly on the plug; never yank the cord.

5

Do not use force when operating switches and knobs.

6

When moving the deck be sure to first pull out the power plug and remove all cords connecting the deck to other equipment.

7

Do not attempt to clean the K-600 with chemical solvents as this may damage the finish. Use a clean, dry cloth.

8

Never allow metallic items (e.g. screwdrivers, tools, etc.) to come near the record/playback head assembly. Doing so may not only scratch or damage the head's mirror-smooth finish, it may change the magnetic characteristics of the heads, causing a deterioration in reproduction performance quality.

9

Although the record/playback head used in the K-600 is a high quality sendust laminate head with outstanding reproduction characteristics, it can become dirty through the use of old tapes or from dust accumulation over time. This can have a serious effect on reproduction quality. Clean the heads regularly with one of the commonly available head cleaners or with cleaning solutions as explained later in this manual.

10

Be sure to read the "Troubleshooting" section of this manual for advice on common operating errors before concluding that your K-600 is faulty.

11

Keep this manual in a safe place for future reference.

K-600

CONNECTION DIAGRAM

Be sure to connect the left (L) and right (R) channels consistently.

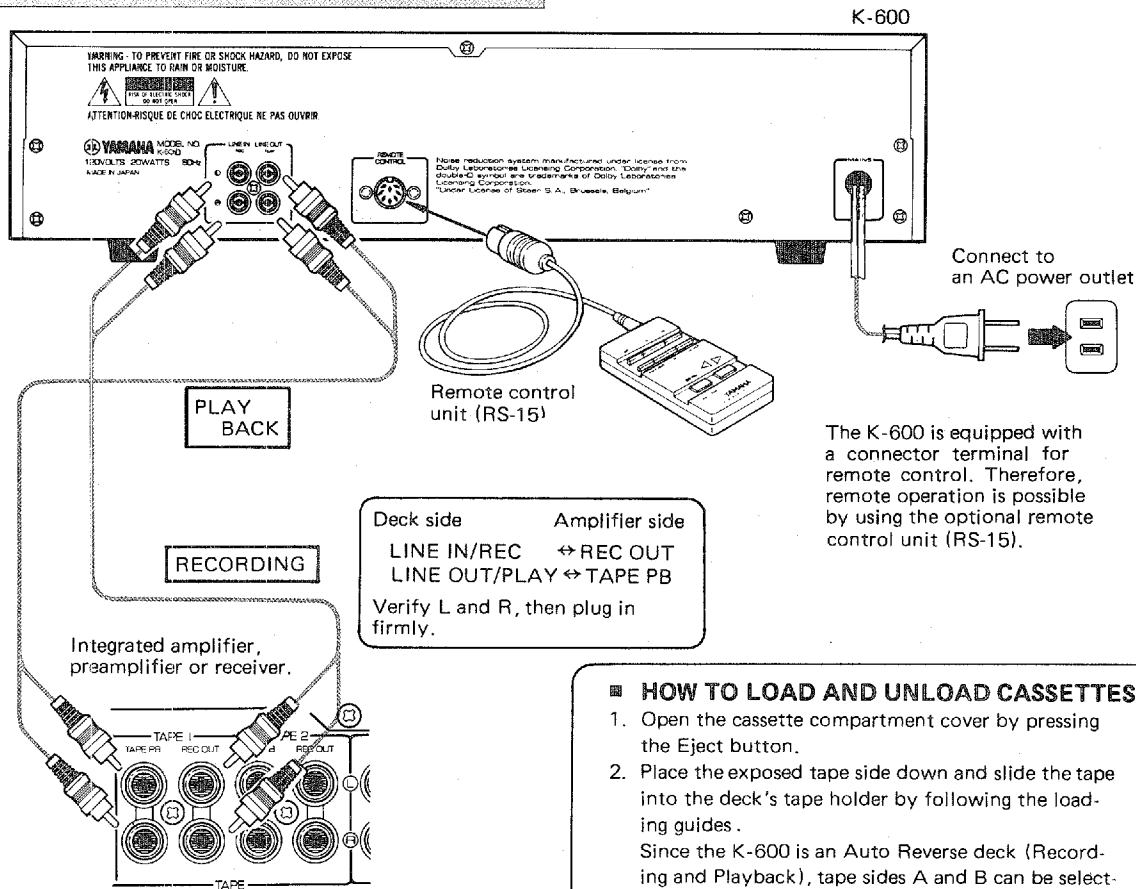

REAR PANEL CONNECTIONS

Connect the power cord to an AC outlet or to the AC outlet provided on the rear panel of your receiver, integrated amplifier, or control amplifier.

Make sure that power to both the K-600 and your amplifier (receiver, etc.) are turned off before making connections. The Line Out (Play) jacks on the K-600 should be connected to the Tape PB (Playback Input) jacks on your amplifier, and the Line In (Rec) jacks on the K-600 should be connected to the Rec Out (Rec Output) jacks on your amplifier. Make sure that the left and right channel connections are properly made, and that the plugs are inserted firmly.

Deck side Amplifier side
 LINE IN/REC ↔ REC OUT
 LINE OUT/PLAY ↔ TAPE PB
 Verify L and R, then plug in firmly.

HOW TO LOAD AND UNLOAD CASSETTES

1. Open the cassette compartment cover by pressing the Eject button.
 2. Place the exposed tape side down and slide the tape into the deck's tape holder by following the loading guides.
 Since the K-600 is an Auto Reverse deck (Recording and Playback), tape sides A and B can be selected by using the travel direction buttons.
 3. Push the cassette cover closed until you hear an audible click.
 4. To unload the cassette, press the Eject button.
- * Remember to keep the cassette compartment cover closed when not using the deck to protect the heads

and inner assembly from exposure to dust and other foreign elements.

The exposed edge of the tape should be facing down when inserted into the cassette compartment for either playback or recording.

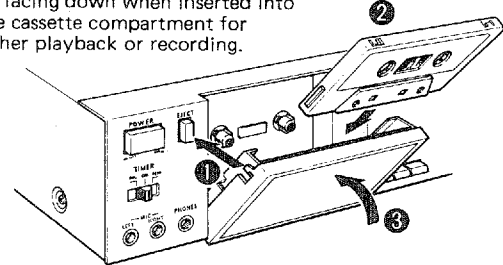

*Please refer to the amplifier instruction manual for more detailed instructions on connecting the deck to your system.

FRONT PANEL PARTS AND FUNCTIONS

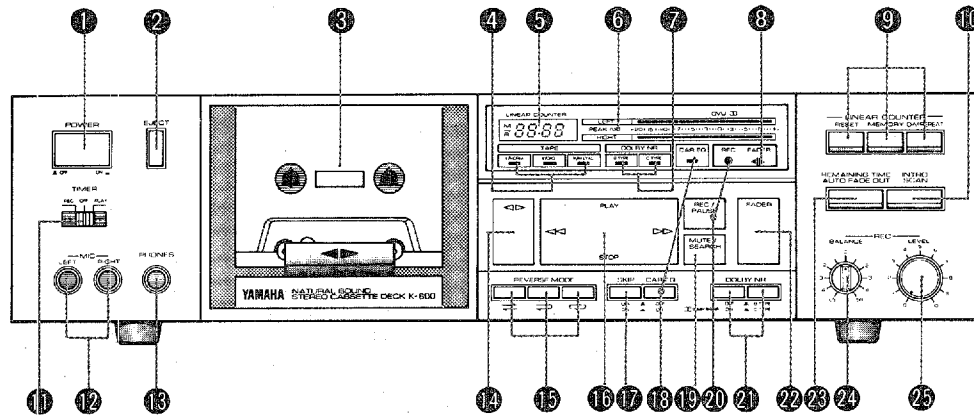

1 POWER SWITCH

This is a "push-on, push-off" type power switch.

2 EJECT BUTTON

To load a cassette tape, press the Eject button and the cassette compartment cover will open. Keep cover closed when the deck is not in use to protect heads and mechanism from dust, etc.

3 CASSETTE COMPARTMENT

4 TAPE INDICATORS

When a tape is loaded, the deck's circuitry will automatically adjust for proper bias, level, and equalization for that type of tape, and the type of tape will be indicated.

- * Automatic tape selection does not function for the old type metal tapes which do not have a detection hole on the cassette shell.
- * This deck is not suited for use with Ferrichrome (FeCr) tapes.

5 LINEAR COUNTER INDICATOR

Microprocessor computation allows real-time indication of the tape's running time in minutes and seconds.

6 PEAK LEVEL METER

Indicates the peak of the signal level during recording and playback cover a range from -20 dB to $+8$ dB.

7 DOLBY NR INDICATORS

The corresponding Dolby NR indicators will light up when the Dolby NR switch is turned on, and either Dolby B or C type noise reduction is selected.

8 FADER INDICATOR

This indicator flashes when the Rec fade in/fade out function is operating. Fade in is engaged from the Rec Pause mode, with the volume being gradually increased to the preset level when the deck is started. This process is reversed for fade out, with volume being gradually decreased to the preset level when the fader button is pressed again and the K-600 automatically set in the Pause mode. When the REMAINING TIME AUTO FADE OUT switch is engaged, the volume is faded out at the end of the tape, the deck reversed, and the volume faded back in at the beginning of the second side; the indicator flashes when this is being carried out.

9 LINEAR COUNTER SWITCHES

RESET This switch is used to reset the Counter; when pressed, the counter will be returned to the "0.00" setting. (If minus figures are being indicated, both the "-" sign and the "M" Memory sign will be cancelled.) At the same time, the Fader indicator will be turned off and Auto Fade Out will be cancelled.

MEMORY This switch is used to set a tape position shown on the indicator into the Memory. When this switch is pushed, the "M" sign will appear in the LINEAR COUNTER indicator. Pushing this switch again will cancel the Memory. When the Memory position is set, the tape will automatically stop at that position during \blacktriangleright or \blacktriangleleft modes.

0-M Repeat: This initiates repeat playback between the "0.00" setting of the counter and the "memorized count number". When this switch is pushed, the "R" sign will appear in the LINEAR COUNTER indicator. If the counter is set to "0.00" at the beginning of a program and the end of the program is memorized, the program can be played back exclusively over and again.

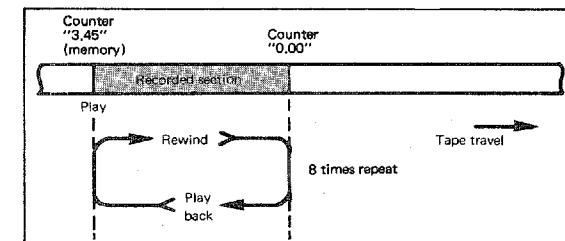

10 INTRO SCAN SWITCH

Pressing this switch allows quick review of all the selections on the tape by automatic playback of the first 10 seconds of each song.

K-600

- * From the Intro Scan mode, the deck can be set in the PLAY, STOP, **▶▶** or **◀◀** modes by pressing the appropriate buttons.

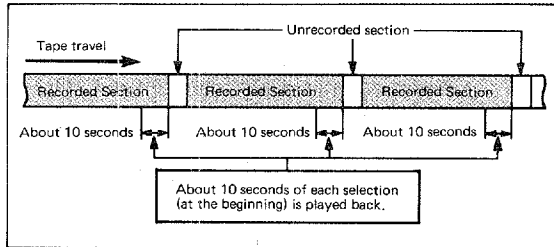

11 TIMER SWITCH

Provides the option of unattended recording or playback when a separate timer unit is used. Set the switch to REC for timer-controlled recording, and to PLAY for timer-controlled playback.

- * When the timer is not being used, set the switch to OFF. If a cassette is loaded in the deck and the switch is left in the REC position, when power comes on the record mode will be engaged, thus erasing the tape.

12 MIC JACKS

Connect a microphone here for live recording. A mic mixer, telephone pickup and other accessories can also be connected here.

- * When a microphone or other device is connected here, it is impossible to record from the input terminal on the rear panel.

13 PHONES JACK

Connection of headphones to the headphone jack allows you to monitor tapes during recording and playback using headphones.

14 DIRECTION BUTTON

Used to set the direction of tape movement. The indicator will show which direction is selected.

15 REVERSE MODE SWITCH

This switch allows repeat playback of a single tape.

- ↔** (Manual reverse) Recording and playback of a single side.

- ↶** (Auto reverse) Recording and playback of both sides (from **▶** to **◀**).
- ↶↶** (Auto reverse repeat) Continuous repeat playback of both sides up to eight times (Once only for recording).

CAUTION:

- * This model uses a light sensor to detect the tape leader for quick auto-reverse. Occasionally, tapes will have colored leaders—this may cause the quick auto-reverse to malfunction. In this case, the tape will reverse after it reaches the end. Also, sunlight or artificial light shining directly on the front of the deck may cause the quick auto-reverse to malfunction.
- * Quick reverse does not function if recording or playback is activated with less than 10 seconds of tape remaining.

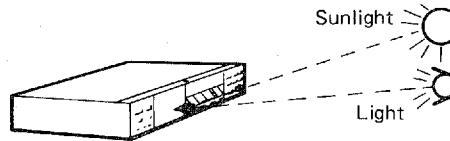

16 REWIND/PLAY/FAST FORWARD/STOP (Tape Travel Operation Control Panel)

- REW** Press the "**◀◀**" section of the control panel to rewind the tape.
- PLAY** Press the "PLAY" section of the control panel for playback. It is also necessary to use this control to engage the record mode. To begin recording, it is necessary to engage the Play mode while in Rec Standby.
- F. FWD** Press the "**▶▶**" section of the control panel to fast forward the tape.
- STOP** Press the "STOP" section of the control panel to stop the tape while in any mode.

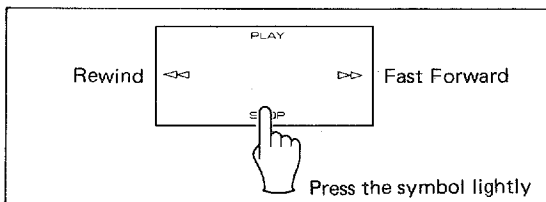

- * Pressing the control panel in between the indicated sections instead of directly on them may give you a mode other than the one you want.

• Auto Stop/Auto Play

- ⏸** engaged: The deck automatically stops at the end of the tape side.
- ↶** engaged: During both recording and playback, the deck will automatically reverse (from **▶** to **◀**) and play to the end of the second side. When fast forwarding, the deck will advance to the end and stop automatically when the **◀◀** control is pushed, and will advance to the end and begin playback automatically when the **◀◀** control is pushed.
- ↶↶** engaged: Auto play will be engaged each time the tape ends when the **◀◀** or the **▶▶** controls are engaged.

17 SKIP SWITCH

When the SKIP switch is pressed, the tape will be automatically fast forwarded to the next selection when an unrecorded tape section of more than 15 seconds occurs.

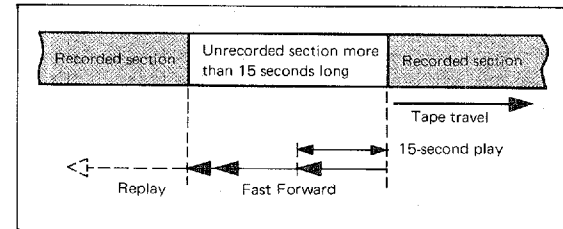

18 CAR EQ SWITCH AND INDICATOR

In order to record with values optimized for car stereo listening, press the switch On. The Car EQ indicator will light. A special equalizer is activated which tailors the recorded signal for richest playback response in a car interior. To neutralize Car EQ, press the switch Off.

19 REC MUTE/SEARCH BUTTON

During Recording: When the MUTE/SEARCH button is pressed at any time during recording, a 4-second blank interval is automatically recorded on the tape. Then, the

Rec Pause mode is engaged automatically. (Auto Rec Mute Operation)

In order to record a blank interval longer than 4 seconds, press the MUTE/SEARCH button and hold it in for the desired length of time. After the button is released, the 4-second blank interval will also be recorded automatically, after which the Rec Pause mode is engaged automatically. To create a blank interval on the tape during continuous recording, press the Play button during rec mute operation. During Playback: By pushing either the ◀◀ or ▶▶ button simultaneously with this button, the tape will be advanced to the beginning of the song either before or after the one being listened to, from which point play will be resumed.

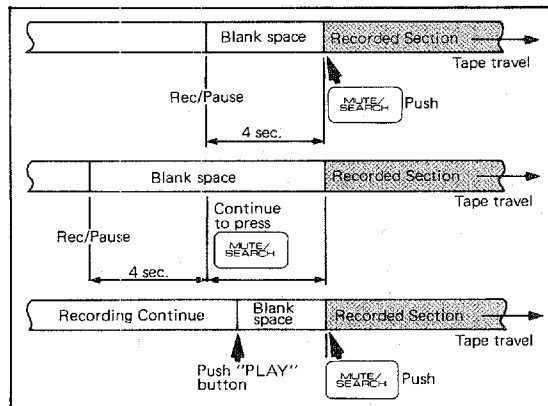

20 REC/PAUSE BUTTON AND INDICATOR

When this button is pushed, the deck will be engaged in the recording standby mode, and the indicator light will come on. The recording level is set in this mode. Recording begins when either the PLAY or FADER buttons are pushed. Recording can be suspended at any time by pressing the REC/PAUSE button; press again and recording will be resumed.

21 DOLBY NR

Dolby noise reduction is an extremely effective method of reducing background hiss on tapes. The K-600 incorporates both Dolby B NR and the newer Dolby C NR system. Dolby C NR is approximately twice as effective as Dolby

B NR.

Switch the Dolby NR system on with the button on the left, then select Dolby B or C NR with the button on the right. Tapes recorded with Dolby B NR should be played back with Dolby B NR on, and tapes recorded with Dolby C NR should be played back with Dolby C NR on. Tapes not Dolby NR-encoded should be played back with Dolby NR off.

* Dolby and the double D mark are trademarks of Dolby Laboratories Licensing Corp. Dolby noise reduction system manufactured under license from Dolby Laboratories Licensing Corp.

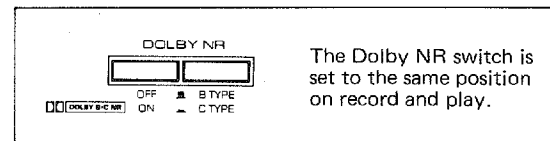

22 FADER BUTTON

With the deck in the Rec Pause mode, pressing this button will activate recording with automatic fade in (the recording level is raised from "0" volume to the preset volume over a space of about 8 seconds). If this button is pressed during recording, the deck will reduce the volume to zero in the 4 second time period 4 seconds blank is recorded, and be set automatically in the Rec Pause mode.

23 REMAINING TIME AUTO FADE OUT SWITCH

Pressing this switch allows remaining unrecorded tape time to be measured and displayed. The AUTO FADE OUT function is also automatically set.

24 REC BALANCE CONTROL

Adjusts relative balance of left and right channel when using the Rec Level control. Set to 0 for normal balance.

25 REC LEVEL CONTROL

Before recording adjust this control for optimum input level. Refer to page 9 for detailed instructions.

* Auto Source Change

When tape playback has finished and the auto stop function has cancelled the play mode, the LINE IN signal (if the tuner is connected to the LINE IN inputs, then

the tuner output signal) will automatically be switched to with a fade in. Signal level can then be adjusted with the REC LEVEL control.

FOR TROUBLE-FREE OPERATION

Skip, etc., are all activated based on unrecorded tape sections of 4 seconds or more; unrecorded tape sections of less than 4 seconds may cause erratic operation. To ensure error-free operation, please follow these procedures:

- * Use tape that is free from static or previously recorded music in the sections between songs.
- * Do not use with tapes that include selections with long silences in the selection.
- * Do not use with tapes that include selections with low level passages.
- * Do not use with tapes of conversations or other recordings with many interruptions.

K-600

REMAINING TIME AUTO FADE OUT SWITCH OPERATION

This switch allows you to easily know exactly how much time remains on the tape for recording. Before using it, use the DIRECTION button to set the deck for the tape side desired.

1. This switch can be used at any point in the tape when the transport is in the STOP mode. The tape is automatically fast forwarded to the end, stopped, and re-wound. During rewinding, a point 10 seconds from the end of the leader is used as the reference point for calculating remaining tape time. The counter is set at 0.00 at this point.
2. Remaining tape time is measured during rewinding, and the tape will be stopped at a point 4 seconds from the end of the last recorded section. The remaining tape time is then displayed on the counter.
3. The deck is now ready to resume recording. And since the K-600 is also equipped with Auto Fade Out, the deck will automatically begin fade out when the counter reaches 0.00 at the tape end.
4. When the deck is in either the "↶" or "↷" mode, recording will continue from Side A to Side B. The deck automatically fades out at the end of the tape, reverses, and fades in at the beginning of Side B.

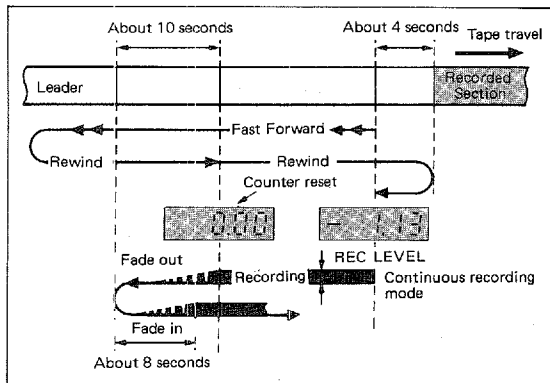

Determining Remaining Tape Time from the Start of the Tape

1. Load a new tape and press the REMAINING TIME/AUTO FADE OUT button.
2. The tape will be automatically fast forwarded to the end and returned to a point 10 seconds from the end of the leader; the counter will be reset to 0.00. Then the tape will be rewound to the beginning and rerun past the leader, where the deck will stop with the time of the tape side displayed by the counter with a "-" (for a Yamaha C-60 tape, this display would be "-31:00").

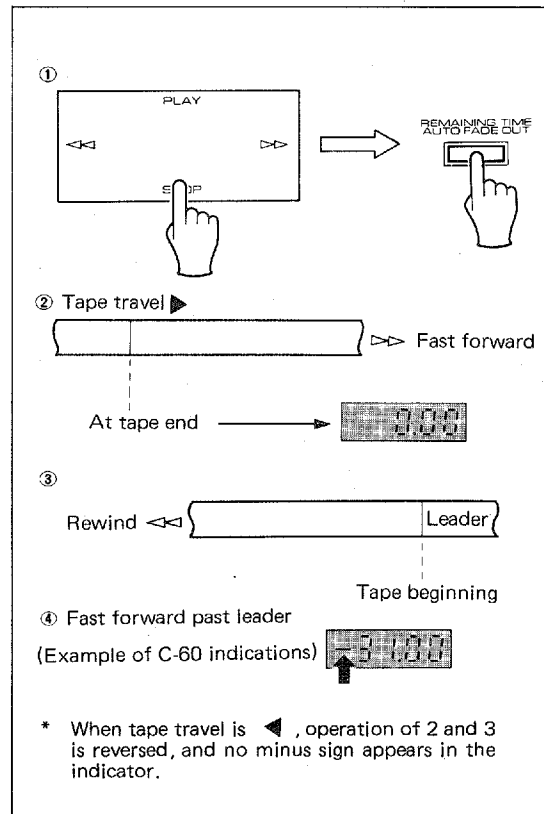

DOLBY C-TYPE NOISE REDUCTION

With cassette tapes, the most noticeable form of noise is high-frequency hiss. To reduce this hiss noise, the K-600 has been equipped with a newly developed Dolby C noise reduction system in addition to its conventional Dolby B NR. Either type of noise reduction may be selected with the switch provided.

Dolby B NR has a noise-reduction effect of about 10 dB in the high-frequency range. The corresponding figure with Dolby C NR is about 20 dB, but this is over the entire range where the human ear is most sensitive to noise (2 kHz to 8 kHz). Dolby C NR also improves the tape's MOL (maximum output level).

Dolby C NR has two new circuits: a spectral skewing circuit and an anti-saturation network. By improving the saturation level of the tape it is possible to prevent high-frequency loss and encode/decode error, etc., improve dynamic range and signal-to-noise ratio, and make it easier to set the recording level. With Dolby C NR, it is possible to achieve the same noise reduction effect at both high and low signal levels and to set the recording level at a point where side effects such as "breathing" are eliminated. Also, by expanding the operating frequency range to two octaves more than that of Dolby B NR, overall noise balance is obtained and the system also becomes effective against high frequencies from the power supply.

The graph shows the frequency response and the noise-reduction effect of recording and playback with Dolby B NR and Dolby C NR. The noise reduction effect of Dolby C NR is larger — approximately 20 dB.

Dolby noise reduction is a 2-part process that acts both on recording and playback; be sure that the Dolby NR switch is set to the same position on record and play.

* Noise in the source material can not be reduced with the Dolby NR system.

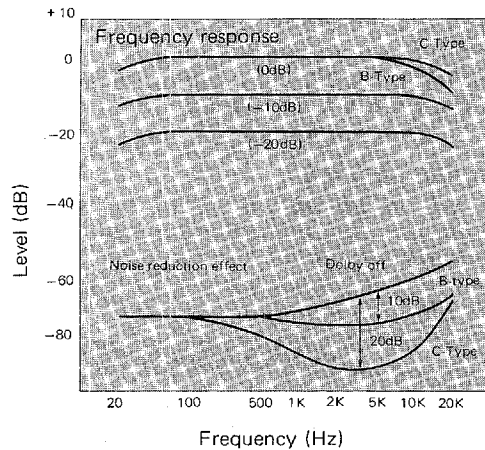

LINEAR COUNTER

In the counter mode, the Linear Counter indicator shows elapsed tape time in minutes and seconds. Operation is as follows:

● **For Constant Display of Remaining Tape Time**
When total recording time is displayed, it is easy to determine remaining tape time during recording.

1. Take any slack out of the tape by winding one of the hubs (a pencil works well here).
 2. Insert the tape in the deck with the tightly wound side on the right (when tape travel is ►; when ◀, place it on the left side).
 3. Reset the counter and rewind the tape.
 4. When the tape is rewound, recording time is displayed with minus ("—") indication.
- Depending on tape travel, when recording is started the indicator will count down toward "0" (-30:00, -29:59, -29:58 . . . or 30:00, 29:59, 29:58 . . .), allowing you to constantly monitor remaining time during recording.

● **Precision of Counter**

The tape counter is not a clock, and so there will be some errors in the time display compared to the actual recording time (this cannot be avoided, as a suitable method is adopted to provide a time display not only during recording and playback, but also during fast forward and rewind). The error depends on the type of tape being used. The table below shows the range of error in the counter display compared to actual tape travel time, for Yamaha tapes run from beginning to end. It may be taken as a reference when using the counter.

Range of error in display compared to travel time of one side of tape (for Yamaha cassette tapes)		
CR-90/MR-90		
↔		
NR-60/CR-X60/MR-60 NR-90/NR-X90		
↔		
-3	-2	-1
Time displayed is too short (Units: min.)		
0	+1	+2
Time displayed is too long.		

CAR EQ

The acoustic environment of an average car interior emphasizes the 200 Hz frequency range while muffling the 50 Hz frequency range. The CAR EQ function, when activated during recording, compensates for these acoustic deficiencies by equalizing according to the curve shown below.

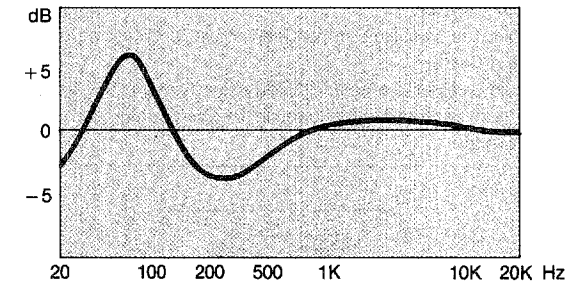

CAR EQ CHARACTERISTICS

K-600

RECORDING AND PLAYBACK

■ RECORDING

● Prior To Recording:

1. Make sure that all power cord connections and all connections between components are properly made.
2. Check that the timer switch is off, then turn on the Power switch.
3. Open the cassette compartment cover by pressing the Eject button.
4. Load a cassette tape and briefly fast forward the tape to get past the leader tape on the beginning of the cassette.

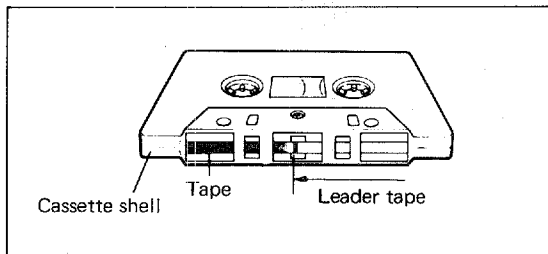

5. For recordings to be made with Dolby NR, turn the Dolby NR switch on, and select either Dolby B or C.
6. Set the Reverse Mode Switch in the desired setting.
7. Press the REC/PAUSE button to engage the Rec Standby mode.
8. Run a sample of the program source to be recorded through the deck so that a proper recording level can be set using the Rec Level controls and the Peak Level meters.

■ SETTING RECORDING LEVEL

In order to make recordings with the best possible signal-to-noise ratio it is important to set the recording level at the highest level possible without introducing distortion. Push the REC/PAUSE button to engage the rec standby mode, and play a section of the program to be recorded. Watch the level meters and adjust the recording level so that the average meter reading is between -3 dB and $+3$ dB, with occasional peaks no higher than $+5$ dB. Adjust the level balance as necessary. Now you are ready to begin recording.

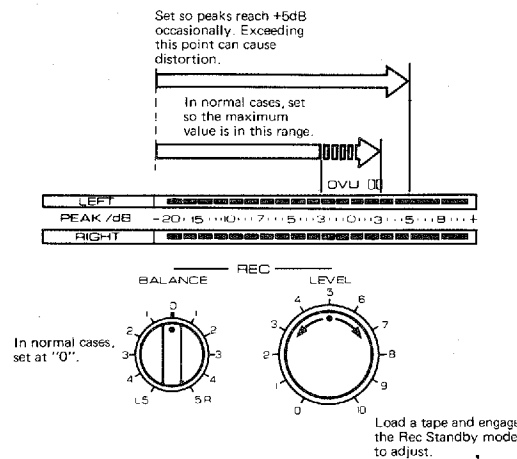

■ STARTING TO RECORD

1. Push FADER button to begin recording with fade in, or PLAY to begin recording conventionally.
2. You can monitor the recording by connecting headphones or through speakers connected to the amplifier.
3. Blank sections on the tape may be created while recording by pressing the MUTE button. This mutes the record amplifiers for as long as the button is engaged.
4. Push the REC/PAUSE button to momentarily suspend recording. Recording is resumed by pressing either the FADER or PLAY button.

5. When you have finished recording, press the "STOP" section of the control panel.
6. Pushing the FADER button while recording will fade out the music and stop the deck.

■ REC RETURN

Pressing the ◀◀ or ▶▶ button when the K-600 is recording will return the tape to the last point where recording was initiated.

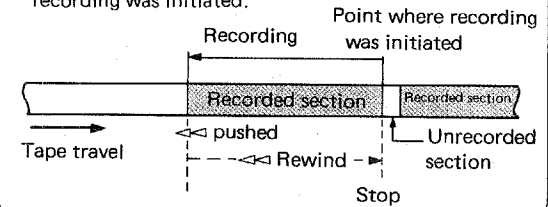

■ PLAYBACK

● Prior to Playback:

1. Make sure that all connections between components and all power cord connections are made properly and securely.
2. Make sure that the Timer switch is set to the OFF position.
3. Turn the Power switch on.
4. Open the cassette compartment cover by depressing the Eject button.
5. Load a recorded tape.
6. For tapes recorded with Dolby NR, make sure that the Dolby NR switch is turned on, and select either Dolby B or C as appropriate.
7. Set REVERSE MODE, and other switches appropriately for listening.

● Beginning Playback:

1. When the "PLAY" section of the control panel is pressed, the Play mode will be engaged.
2. Adjust the Balance, Volume, and Tone controls of your amplifier to the desired settings.
3. Press the "STOP" section of the control panel to end play.

TIMER RECORDING/PLAYBACK

When using the Timer Rec/Play switch in combination with a conventional audio timer such as the Yamaha DT-2, it is possible to make recordings and initiate playback at any time automatically by presetting the deck in advance.

● Timer Recording:

1. Refer to the Connection Diagram and make sure that all power cord connections between the timer and amplifier are properly made. No change in any of the other connections between deck and amplifier, etc., is necessary.
2. After turning on the power to each component, select the station on your FM tuner which you want to record and turn down the volume on your amplifier. This will have no effect on the recording signal level. Remember to set the proper recording level for taping from the tuner (as explained earlier in this manual) prior to setting the deck for timer recording.
3. Following the instructions given in the "Prior To Recording" section of this manual, put the K-600 into the Rec mode.
4. Set the Timer switch to the REC position.
5. Set the timer to the desired times. It is advisable to set the timer to begin recording slightly before the actual recording time, and to end slightly before the actual recording time, so that you leave some room for later editing.
6. The timer will send power to the amplifier, tuner and deck at the preset time, turning all the components on and initiating the recording mode.

CAUTION:

Set timer by moving dial forward only.

- * If the tape cannot be ejected after timer recording, turn the timer switch off and the K-600's power switch on; the tape can then be ejected.

● Timer Playback:



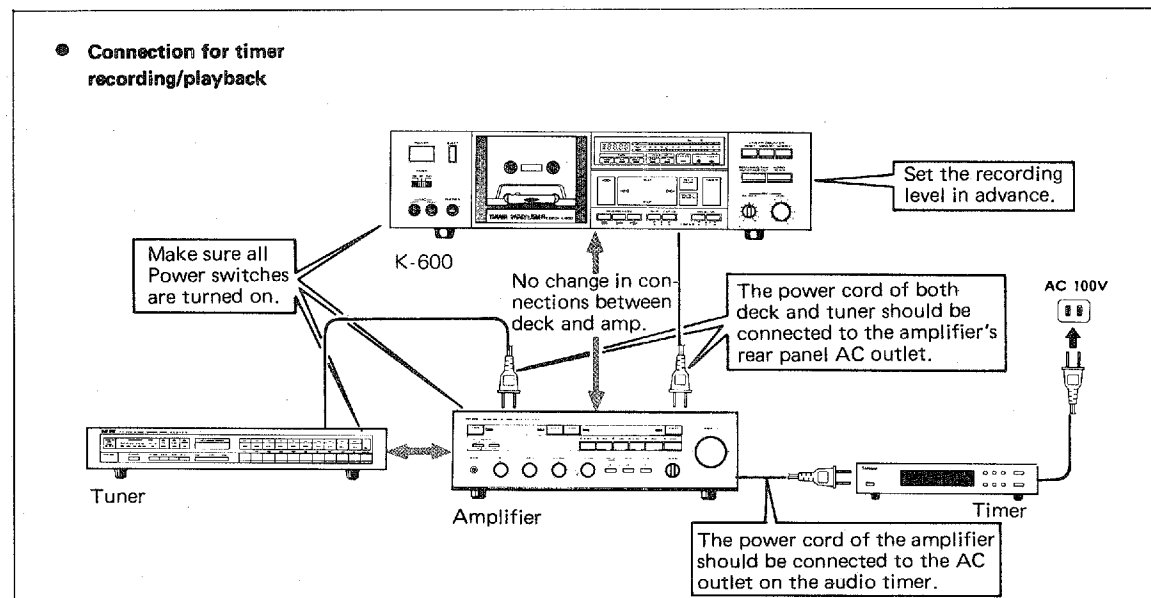



1. All connections are the same as for timer recording.
2. Following the instructions given in the "Prior To Playback" section of this manual, put the K-600 into the Play mode.
3. Turn on the amplifier and adjust the Balance, Volume and Tone controls.
4. Set the input mode selector of your amplifier to the Tape mode.
5. Set the timer to shut off at the time you wish to end playback.
6. Set the Timer switch on the K-600 to the PLAY position.
7. At the preset times, the timer will turn power on to the amplifier and tape deck and begin playback. It will shut power off, at the preset time as well, ending playback.



K-600

MAJOR FUNCTIONS

- The most commonly used operating functions for recording and playback are listed below. To familiarize yourself with them, operate the deck while referring to the explanation of each function.

	Item	Switch To Use	Page No.
Recording	Fade in/fade out at any point in the tape.	⑫ 	6
	Automatic fade out at tape end.	⑬ 	7
	Remaining tape time indication — how much recording time is left in the tape.	⑬ 	7
	Returning to the beginning of the song during recording.	Press { << } { >> }	9
	Cutting out undesirable portions while recording.	⑭ 	5, 6
Playback	Jump to the beginning of the previous or next selection while listening to a song.	⑮ Press << or >> ⑯ and  simultaneously	5, 6
	Quick review of the selections recorded on the tape.	⑩ 	4, 5
	Automatic playback of tuner when the tape has finished.	Connect tuner's output line to K-600's LINE IN jack; adjust volume with REC LEVEL control.	6
Other	Set memory to automatically stop tape at any point.	⑨ 	4

■ MAINTENANCE OF YOUR K-600

After using your K-600 for a certain length of time, it is possible that the sound of your tapes may deteriorate with fading, vibration, or noise as a noticeable result. This is caused by an accumulation of dirt or dust on the heads, capstan, or pinch roller, and magnetization of the heads. It is advisable to periodically clean and demagnetize the heads and to clean the capstan and pinch roller. Use a commonly available cotton swab and head cleaning solution to do this, or use a special head cleaning tape. Head demagnetizers are also commonly available.

- * When cleaning the heads, be careful not to apply unnecessary pressure. When demagnetizing the heads, be sure to follow the instructions of the head demagnetizer carefully.
- * For better access to the head assembly, the cassette compartment cover is detachable by pulling upward on it after it has been opened. To reattach it, reverse the same procedure.

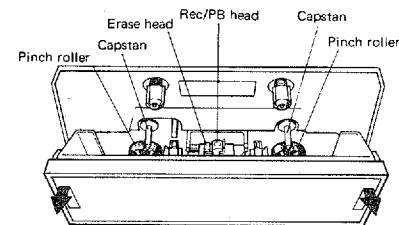

CASSETTE TAPES

■ CASSETTE TAPES

There are many different types of cassette tapes available, however, they all conform to standard specifications, so any brand may be used with the K-600.

● Classification of cassette tapes by time

Cassette tapes are commonly classified according to the number of minutes of recording time on both sides of the tape.

Type	Record/Playback Time		Length of Tape (m)
	One way (Min.)	Two way (Min.)	
C - 45 (C - 46)	23	45 (46)	68
C - 60	30	60	90
C - 90	45	90	135

* Yamaha does not recommend the use of C-120 cassettes since the extreme thinness of the tape makes them susceptible to mechanical and electrical problems.

● Classification of Cassette Tapes by Formulation

Cassette tapes are available in four basic types depending on their formulation, or type of magnetic material and manufacturing process. These four types are commonly known as Normal (LH), Chrome (CrO₂), Ferrichrome (FeCr), and Metal (Metal) and they each require specific bias, level, and equalization settings for optimum performance. Most cassette decks provide a tape type selector which gives you the proper bias, level, and equalization settings according to which type you have selected. The K-500, however, does not have such a tape selector. Instead, it has an Auto Tape Selector which automatically adjusts for the proper bias, level and equalization according to the tape formulation — all you have to do is load a cassette and the Auto Tape Selector does the rest.

* Old-type Metal tape cassette shells do not have the necessary hole for Auto Tape Selector operation. It is recommended that you do not record with this kind of Metal cassette. However, Metal tape cassette re-

corded on another deck may be played back with the K-600 at the Chrome (CrO₂) settings. All current cassette tapes will have this small opening in the cassette shell, so be sure you use suitable cassettes with the K-600. Cassette shell structure of current tape types is shown below, illustrating this feature:

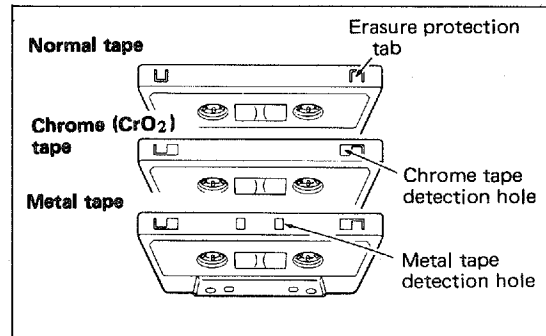

* The K-600 does not have the required settings for Ferrichrome (FeCr) tape, since this tape formulation is not widely used. Should you use a Ferrichrome tape, it will be recorded and played back at the Normal (LH) settings, and this will result in an unnatural high frequency emphasis. This effect may be compensated for somewhat by adjusting the tone controls of your amplifier.

■ TAKING UP SLACK IN THE TAPE

Slack in the tape inside of the cassette shell can be corrected by simply inserting a pencil into one of the spools and winding it until all the slack is taken up.

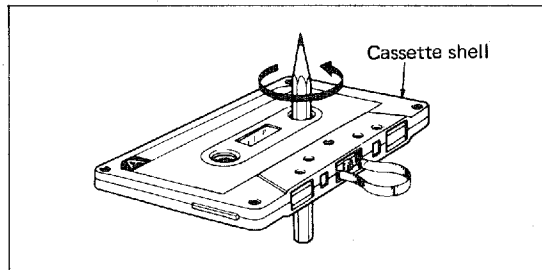

■ PROTECTING YOUR RECORDINGS

All cassette tapes are provided with erasure protection holes to prevent recorded tapes from being accidentally erased. There is a small tab covering the hole on each cassette, and it should be broken off with a screwdriver after recording a tape. Without this tab covering the hole, it is impossible to record on that tape again; thus, you can keep any recorded tape for as long as you wish without fear of accidental erasure. Should you wish to use a cassette tape protected in this way for later recording, simply covering the hole with cellophane tape will permit erasure and re-recording.

* When using Chrome (CrO₂), Metal tape, make sure you do not cover the hole intended for the Chrome tape formulation check. (Refer to the illustration of cassette shells according to tape formulation for correct identification of each.)

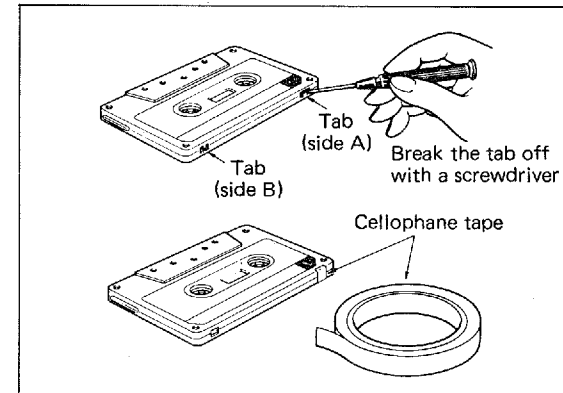

■ STORAGE OF YOUR CASSETTES

After putting a cassette back into its case, store in a location away from exposure to direct sunlight, humidity, high temperatures, and magnetic fields (away from television sets, speakers, etc.). High temperatures and humidity will damage the tape itself, while exposure to magnetic fields may cause a loss of recorded material.

K-600

TROUBLESHOOTING

When your cassette deck fails to function properly, before assuming it is faulty, check the following troubleshooting list. It details the corrective action you can take yourself without having to call a service engineer. If you have any doubts or questions, get in touch with your nearest Yamaha dealer.

Fault	Cause	Cure
Tape doesn't move in recording or playback.	<ul style="list-style-type: none"> ● Power plug not properly plugged in. ● End of tape. 	<ul style="list-style-type: none"> ● Reinsert plug properly. ● Rewind tape or flip it over.
Rec Standby button fails to function.	<ul style="list-style-type: none"> ● No cassette tape loaded. ● Protective tab broken off. 	<ul style="list-style-type: none"> ● Load a cassette tape. ● Change to different tape, or cover the hole remaining after removal of tab with cellophane tape.
Sounds become faint and sometimes inaudible.	<ul style="list-style-type: none"> ● Head is dirty. ● Head is magnetized. ● Tape transport section dirty. 	<ul style="list-style-type: none"> ● Clean head using cleaning tape. ● Demagnetize head using head demagnetizer. ● Change to different tape.
Playback sounds are poorly balanced.	<ul style="list-style-type: none"> ● Dolby NR switch not properly set. 	<ul style="list-style-type: none"> ● Dolby B-encoded tapes: play back with Dolby B on. ● Dolby C-encoded tapes: play back with Dolby C on. ● Others: Dolby off.
Recorded sounds are distorted.	<ul style="list-style-type: none"> ● Recording level is too high. 	<ul style="list-style-type: none"> ● Check input level with meter and use lower rec level when recording.
Excessive noise.	<ul style="list-style-type: none"> ● Head is dirty. ● Head is magnetized. ● Worn out or poor quality tape. ● Connection(s) improperly made. ● Affected by external electrical noise. 	<ul style="list-style-type: none"> ● Clean head. ● Demagnetize head with head demagnetizer. ● Change to better tape. ● Check input and output connections and reinsert properly. ● Move away from electrical appliances (TV, fluorescent light, electric blanket, etc.)
Excessive wow (wavering of the sound).	<ul style="list-style-type: none"> ● Dirty capstan, pinch roller, etc. or poor tape. ● Tape is unevenly wound. 	<ul style="list-style-type: none"> ● Clean capstan, pinch roller, or change to better tape. ● Rewind tape.
Tape stops or reverses during recording or playback.	<ul style="list-style-type: none"> ● Slack tape, or tape spillage wound around capstan. ● A strong light is reflecting on deck front. 	<ul style="list-style-type: none"> ● Insert pencil in hole in cassette shell and turn to take up slack. ● Remove light source.
"Howling" sounds generated during MIC recording.	<ul style="list-style-type: none"> ● Microphone located too close to speakers. 	<ul style="list-style-type: none"> ● Move mike away from speaker or lower volume of amplifier.
Fails to record.	<ul style="list-style-type: none"> ● Rec Level control too low. ● Protective tabs broken off. 	<ul style="list-style-type: none"> ● Adjust rec level control. ● Change tape or cover protective hole with cellophane tape.
Does not skip to beginning of selection. Intro Scan does not operate.	<ul style="list-style-type: none"> ● Recorded section is too short. ● Recorded section has low-level portions. Conversations, etc. have been recorded. 	<ul style="list-style-type: none"> ● Blank sections must be at least 4 seconds long. ● Refer to page 6 for other possible causes.

SPECIFICATIONS

Track Configuration	4 track, 2 channel stereo
Motor	DC servo motor (capstan), Flat torque DC motor (reel); DC motor (mech.)
Head System	Sendust rotary rec/playback head system: double gap ferrite erase head
F. Fwd/Rew Time	90 sec. (C-60)
Wow & Flutter WRMS/W.PEAK	less than 0.02%/less than ±0.08%
Signal-to-Noise Ratio	
Dolby NR off	better than 59 dB
Dolby B on	better than 67 dB
Dolby C on	better than 75 dB
Frequency Response (-20 dB)	
Normal Tape	30 ~ 16,000 Hz ± 3 dB
CrO ₂ Tape	30 ~ 18,000 Hz ± 3 dB
Metal Tape	30 ~ 19,000 Hz ± 3 dB
Total Distortion	
Normal Tape	less than 1.0%
CrO ₂ Tape	less than 1.0%
Metal Tape	less than 1.0%
Input Sensitivity/Impedance	
Mic	0.3 mV/5 k-ohms
Line	60 mV/47 k-ohms
Output Level	
Line	350 mV/47 k-ohms
Phones	70 mV/8 ohms
Power Supply	120 V 60 Hz
Power Consumption	20 W
Dimensions (W x H x D)	435 x 113.5 x 302.5 mm (17-1/8" x 4-1/2" x 11-7/8")
Weight	5.2 kg (11 lbs. 7 oz.)

Specifications subject to change without notice.
*TM Dolby laboratories Licensing Corp.

■ YAMAHA NATURAL SOUND CASSETTE TAPES

A Perfect Tape for Every Need

Every type of recording requirement demands a special kind of tape. Yamaha has specially blended tape to meet each requirement, featuring low distortion and wide dynamic range, as well as precision engineering to ensure stable tape transport and ideal tape to head contact.

★ **MR 60/90 min.**
Bias: Metal, EQ: 70 μS
For Reference Quality Music
Recording

★ **CR-X 60/90 min.**
Bias: High (CrO₂), EQ: 70 μS
For Top-Priority Music Recording

★ **CR 60/90 min.**
Bias: High (CrO₂), EQ: 70 μS
For Selected Music Recording

★ **NR-X 60/90 min.**
Bias: Normal, EQ: 120 μS
For High-Definition Music
Recording

★ **NR 60/90 min.**
Bias: Normal, EQ: 120 μS
For Universal Music Recording

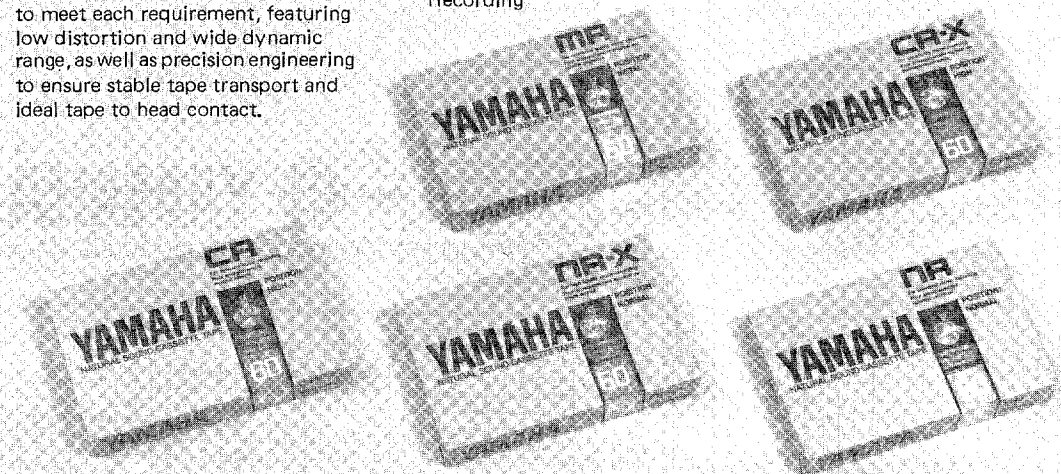

SINCE 1887  **YAMAHA**
NIPPON GAKKI CO., LTD. HAMAMATSU, JAPAN